



My Cat Pat In A Hat



Pat, the fat brown cat,

b

br

c

ch

dr

h

at

My at family hat

s

sl





spl





th

v

Pat, the fat
brown cat, with
the funny blue
hat, sat on a flat
red mat,
by a little
black
bat.



	cat
	bat
	hat
	rat

	cat
	bat
	hat
	rat

Write these at family words in alphabetical order on the hat.

drat
vat
brat
splat
that
rat
fat
cat
slat
sat
mat
hat
bat
chat
flat
pat

My Cat Pat
Pat, the fat
brown cat,
with the funny
blue hat, sat on

My Itty Bitty Book Of at Family Words <small>Trace and write.</small>	chat	mat	splat
at	drat	pat	that
bat	fat	rat	vat
brat	flat	sat	
cat	hat	slat	

bat	rat
brat	sat
cat	slat
chat	splat
drat	that
fat	vat
flat	
hat	
mat	
pat	

Name: _____

Color and trim.





My Cat Pat In A Hat

By: _____





Pat, the fat brown cat,
with the funny blue hat,
sat on a flat red mat,
by a little black bat.

Number the pages. Cut them into strips. Staple them to the brim of the hat.

<input type="checkbox"/> at 
<input type="checkbox"/> at 
<input type="checkbox"/> at

c r b h

bat	cat	hat
mat	rat	

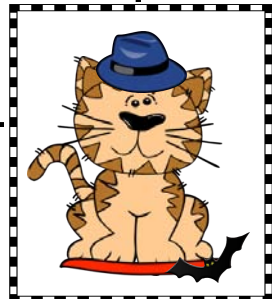

The at Word Family

at	fat	rat
bat	flat	sat
brat	hat	slat
cat	mat	splat
chat	pat	that
drat		vat

